

- 0.7" voice coil Epotex former
- Treated silk dome
- Neodymium magnet circuit
- Ferrofluid in the air gap
- 89.3 dB sensitivity

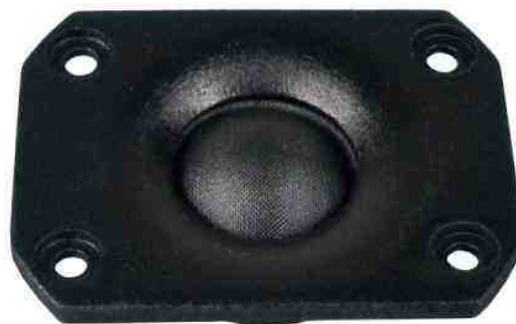

Specifications	
Nominal Dimensions	38x50mm
Nominal Impedance	4Ω
Rated Power AES ⁽¹⁾ (4500 - 20000 Hz)	12W
Continuous Program Power ⁽²⁾	24W
Rated Noise Power (IEC 60268-5) ⁽³⁾	50W
Sensitivity @ 1W/1m ⁽⁴⁾	89.3dB
Voice Coil Diameter	18mm (0.7")
Voice Coil Winding Depth	1.8mm
Magnetic Gap Depth	2.0mm
Flux Density	1.10T
DC Resistance	3.00Ω
Resonance Frequency	2400Hz
Magnet Weight	5g
Net Weight	0.03kg
Recommended Crossover Frequency	4.5kHz

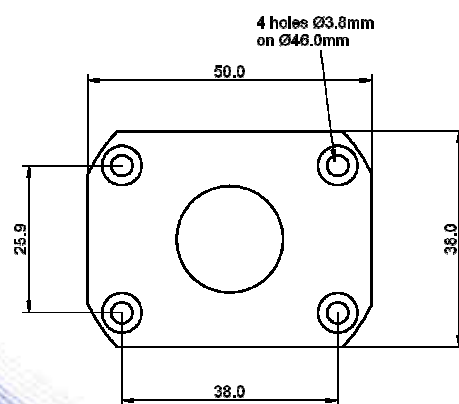

Constructive Characteristics	
Magnet	: Neodymium
Voice Coil Winding Material	: Copper
Voice Coil Former Material	: Epotex
Diaphragm	: Treated Silk
Ferrofluid in Air Gap	: Yes
Flange	: Nylon Fiberglass Doped
Spare Part Code	:

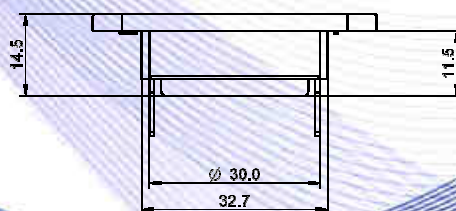

Free Air Frequency Response @ 1W,1m – Free Air Impedance

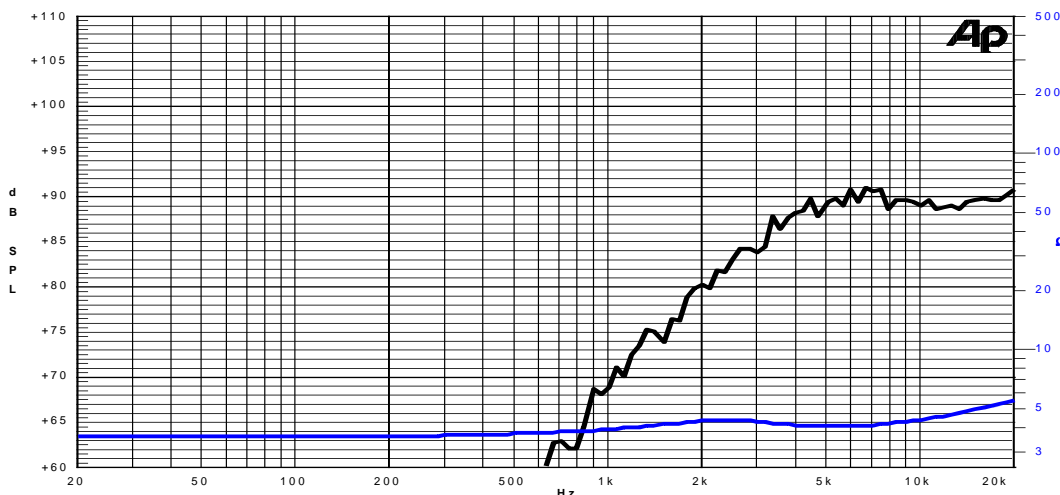

Note:

- 1 : Rated Power measured with 2 hours test with pink noise signal, 6dB crest factor, loudspeaker mounted on enclosure
- 2: Power on Continuous Program is defined as 3 dB greater than the Rated Power
- 3: Rated Noise Power measured with 100 hours test pink noise, 6dB crest factor IFC60268-5 filtering
- 4: Measured at 1W,1m in axis within the frequency range
- 5: Drawing dimensions: mm