

- 1,5" voice coil Kapton former
- Ferrite magnet
- 94.4 dB sensitivity



Specifications	
Nominal Diameter	209mm (8")
Nominal Impedance	4Ω
Rated Power AES <sup>(1)</sup>	100W
Continuous Program Power <sup>(2)</sup>	200W
Sensitivity @ 1W/1m <sup>(3)</sup>	94.4dB
Voice Coil Diameter	38mm (1,5")
Voice Coil Winding Depth	11mm
Magnetic Gap Depth	6mm
Flux Density	1.16T
Magnet Weight	640g
Net Weight	2.0kg

Thiele & Small Parameters <sup>(4)</sup>			
Re	3.18Ω	Fs	71.0Hz
Qms	2.44	Qes	0.46
Qts	0.39	Mms	18.6g
Cms	270μm/N	Bxl	7.58Tm
Vas	17.5l	Sd	213.8cm <sup>2</sup>
X max <sup>(5)</sup>	+/-2.5mm	X var <sup>(6)</sup>	+/-3.5mm
η <sub>0</sub>	1.31%	Le (1kHz)	0.46mH

Constructive Characteristics	
Magnet	: Ferrite
Basket Material	: Pressed Sheet Steel
Voice Coil Winding Material	: Copper
Voice Coil Former Material	: Kapton
Cone Material	: Paper
Cone Treatment	: No
Surround Material	: Treated Cloth
Dust Dome Material	: Solid Paper

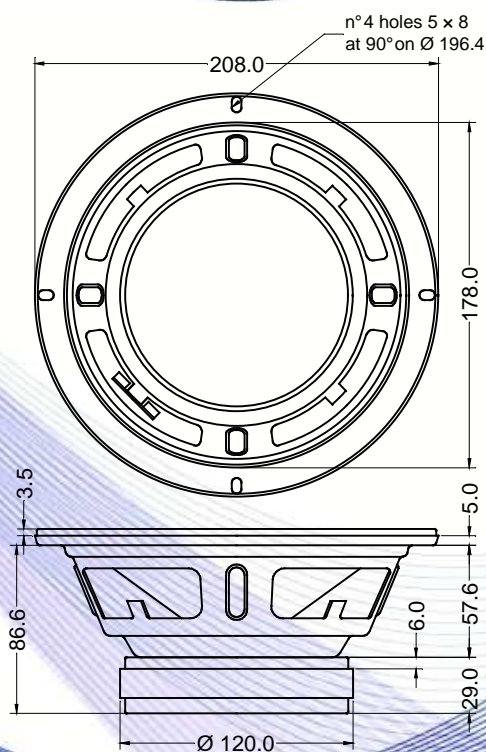

Frequency Response on IEC Baffle (DIN 45575) @ 1W,1m – Free Air Impedance

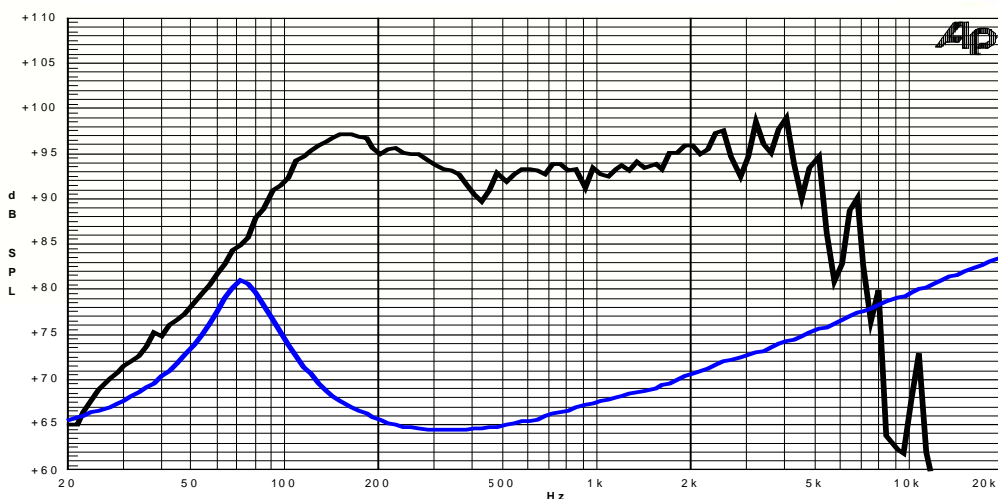

- Note:
- 1 : Rated Power measured with 2 hours test with pink noise signal, 6dB crest factor, loudspeaker mounted on enclosure
  - 2: Power on Continuous Program is defined as 3 dB greater than the Rated Power
  - 3: Calculated by Thiele & Small parameters
  - 4: Thiele & Small parameters measured with laser system without preconditioning test
  - 5: Measured with respect to a THD of 10% using a parameter-based method
  - 6: Value corresponding to a decay of the Force Factor, or Compliance, or both, equal to the 50% of the small signal value.
  - 7: Drawing dimensions: mm
  - 8: The notch around 400Hz on the frequency response is typical of the measurement on IEC baffle